



# 1080 TOC

TOTAL ORGANIC CARBON ANALYZER

# Easily Analyze Difficult to Oxidize Samples



Total organic carbon (TOC) measurement is a well-established technique that provides valuable information about water quality for process control and regulatory compliance. Though high-temperature combustion TOC has been shown to be very effective for the analysis of samples that are of a high molecular weight or contain substantial amounts of salt or difficult-to-oxidize organics (e.g, humic acid), these types of samples are problematic for combustion TOC analyzers. They can clog the instrument, cause catalyst poisoning, and shorten the injector life, leading to unreliable data, increased catalyst costs, and a significant amount of downtime for servicing the instrument.

With over 45 years of experience in designing TOC analyzers, OI Analytical brings game-changing technology to combustion TOC analysis for the accurate results you need with a low cost of ownership and unprecedented ease of use and maintenance. Engineered for unsurpassed reliability and simple operation, the Model 1080 Total Organic Carbon Analyzer handles even the most challenging applications without the need for expensive additional kits, modules or special options.

## Test Methods Supported

The high-temperature combustion technique has been approved and adopted in numerous regulatory compliance methods, standards, and norms for water quality testing.

### Method

USEPA 415.1  
Standard Method 5310B  
USEPA 9060A  
USEPA-DBPR  
ISO 8245  
EN 1484  
ASTM D7573-09

### Sample/Application

Drinking Water  
Wastewater, Ground & Surface Waters  
Wastewater, Ground & Surface Waters  
Disinfection Byproduct Rule  
Drinking Water, Wastewater  
Surface & Ground Water, Potable Water  
Water, Wastewater, Sea Water

Drinking Water

Municipal Wastewater

Industrial Wastewater

Sewage Effluent

Sea Water

Ground Water / Surface Water



# Designed for Performance & Simplicity



## Engineered for Performance

High-temperature catalytic combustion oxidizes and converts the organic compounds present in aqueous samples to  $\text{CO}_2$  for measurement by a solid-state, non-dispersive infrared (SS-NDIR) detector. Patent-pending technologies protect the catalyst, increase reliability, reduce maintenance and operating costs, and extend the life of the instrument.

## Automation

The 1080 TOC also offers automatic sample acidification and sparging. The automatic dilution function reduces sample salinity, acidity, and alkalinity, significantly extending the dynamic range.

## Priority Samples on the Fly

With intuitive software features, priority samples can be added at any time without interrupting the operation of the instrument.

## Increased Throughput

The Model 1088 Autosampler analyzes up to 88 samples unattended freeing the operator's time for other projects.

## Compact

The autosampler was designed to fit beneath the 1080 TOC, conserving bench space.

## Total Nitrogen

The 1080 TOC has also been designed to accommodate total nitrogen measurement, eliminating the need for dangerous high voltage components associated with ozone generation and scrubbers. OI Analytical's new design ensures that there is no interference from metallic ions or bromine in difficult to analyze samples like sea water.

# 1080 High-Temperature Combustion TOC Analyzer

Our experienced team of chemists and engineers set out to design an instrument that would make TOC analysis easy and affordable. The new technology of the 1080 Combustion TOC Analyzer inspires confidence in results, lowers operating costs, and ensures reliability.

## Ease of Operation

The 1080 TOC Analyzer was designed with the operator in mind. It has been carefully engineered to provide an intuitive workflow experience. You can view the instrument status at a glance from anywhere in the lab with the TruColour™ LED Indicator.

## Low Cost of Ownership

OI Analytical's newly developed technologies are designed to keep the cost of ownership low by extending the life of the instrument and its components.

## Serviceability

Critical components, such as the combustion tube, furnace and consumable parts, are quickly and easily accessed through a side panel making maintenance simple. When necessary, the catalyst can be packed in a matter of minutes to minimize instrument downtime.

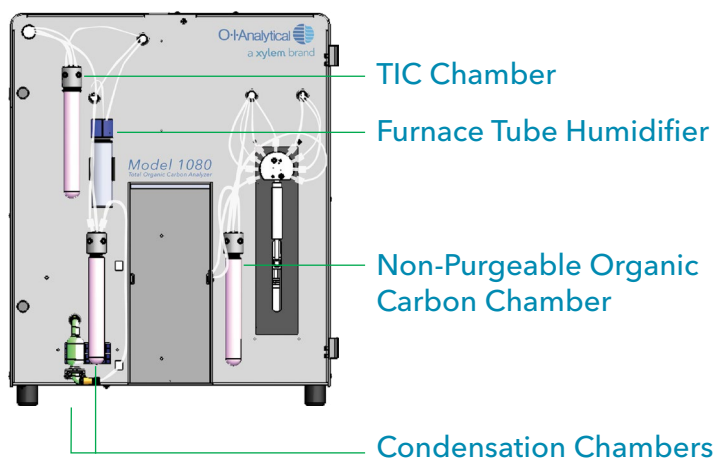

## 1080 TOC Features

### Solid-State Non-Dispersive Infrared Detector (SS-NDIR)

Reduces interferences from other compounds for accurate and reproducible results.

### Electronic Pressure Control (EPC)

Utilized for critical flow adjustments.

### Easy Accessibility

Open architecture provides easy service access to critical components and reagents.

### LIMS Connectivity

Measurement results can be easily transferred to Laboratory Information Management Systems.

### Video Tutorials

Reduce training time with quick access to OI Analytical knowledge base.

### Intuitive Software

Simple, icon-driven interface and user-friendly functionality.

**Superior sample flexibility with no loss in precision**

Large or small, sample size is no longer a problem! The new pulsed time injection® more accurately injects sample volumes for greater flexibility over a large range.

**Reduce instrument downtime**

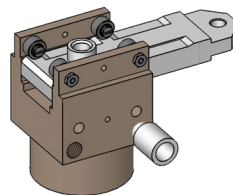

OI Analytical's Smart Slide Injector® significantly extends the life of the injector, reducing operating costs.

**High sensitivity for difficult samples**

A novel stop-flow process converts the sample to steam prior to detection for improved low-level sensitivity.

**Non-Combustible salts? Not a problem!**

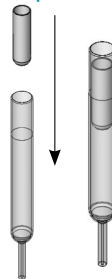

Our specially designed Catalyst Guard® combustion reactor comes standard with the 1080 TOC, protecting the platinum catalyst for extended life and consistent oxidation conditions. No need for expensive add-ons or options!

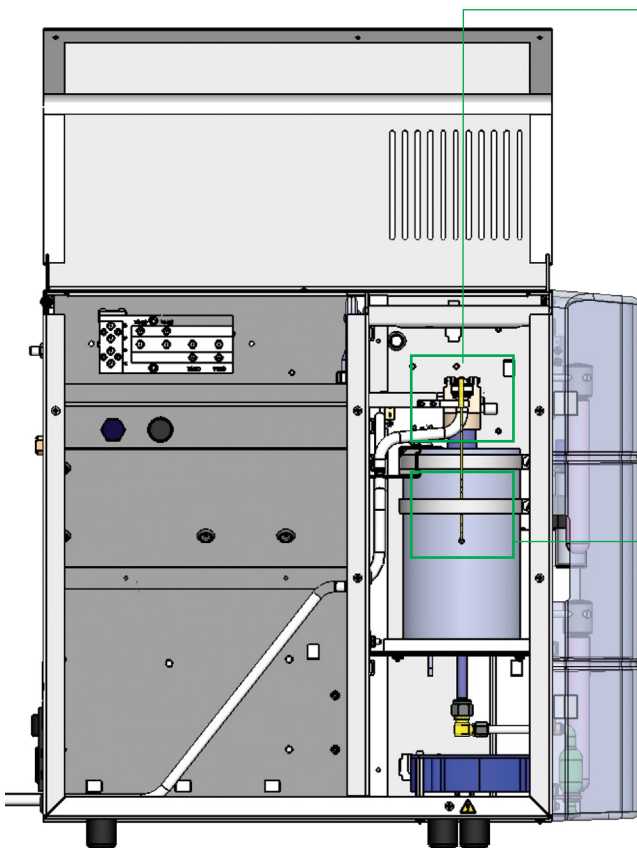

**Compact design**

The large reagent storage area accommodates the DI water container, as well as up to three 1-L containers for acidic reagents necessary for sample sparging. All containers are stored out of the way for added space savings, but conveniently located for easy access and service.

# TOC View Software Interface

The **TOC View Software** provides fully automated data collection, analysis, reporting, and storage in a LIMS environment using a logical, easy-to-follow layout.

## Methods Menu

Create methods for the analysis of a wide variety of samples for optimal results.

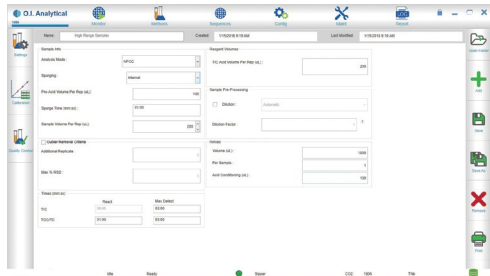

## Sequences Menu

Easy to setup and priority samples can be added on the fly.

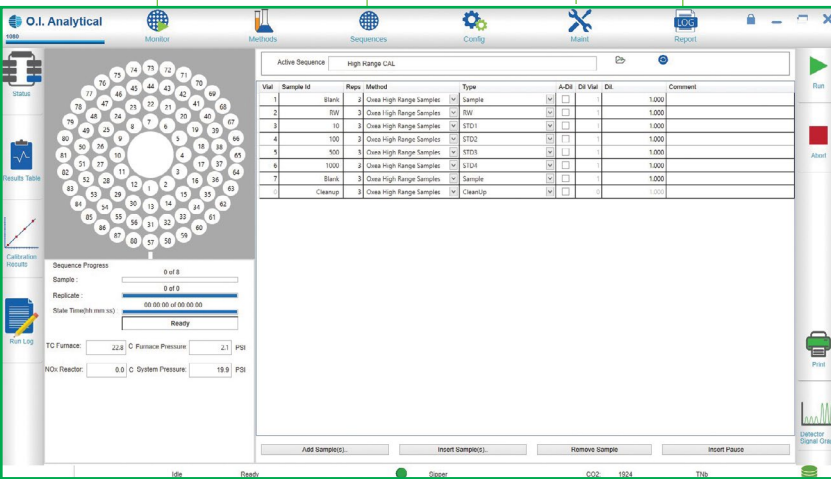
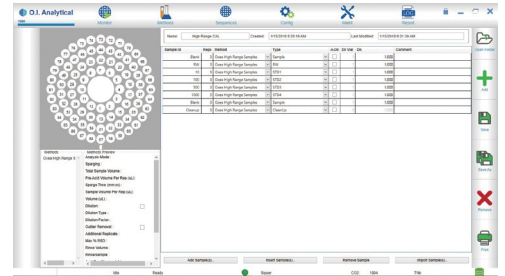

## Main (Monitor) Menu

Quickly and easily monitor sequence status and other important instrument parameters at a glance.

## Calibration Menu

Quick and easy access to method calibration setup and results.

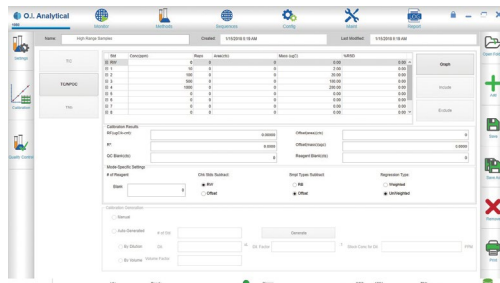

## Maintenance Menu

Perform routine checks and tests at the touch of a button.

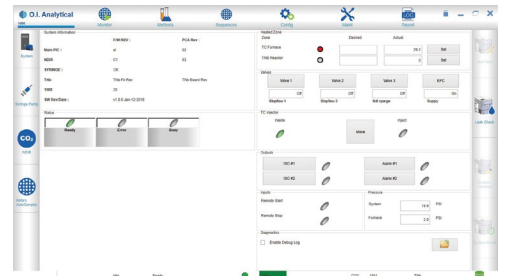

## Reports Menu

Review results, generate customized reports, and export data to LIMS. TOC Reporter supports sample and customer ID Tracking of trending analysis.

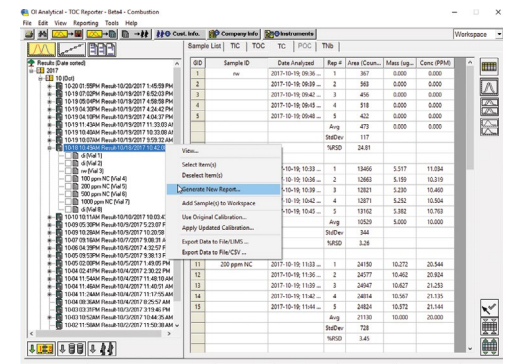

## Sea Water Application Results

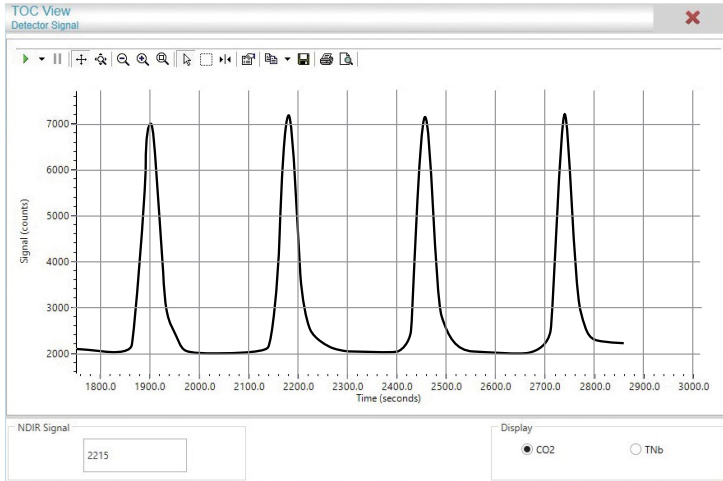

**Measurement Method:** NPOCi with sample acidification  
**Measurement Results:** 10-ppm C in 3.5% NaCl matrix after 4700 injections

## Environmental Sample Results

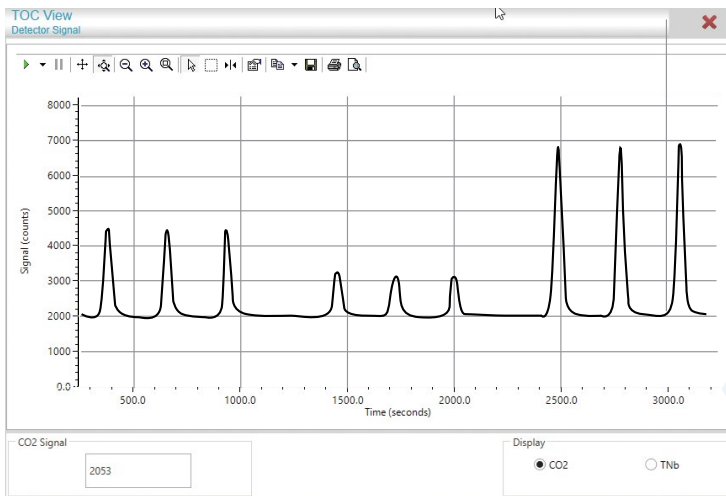

**Measurement Method:** TOC measurement (NPOC) with sample acidification and sparging  
**Measurement Results:** (L-R): Ground Water (1.02 mg/L; 1.0% RSD)  
 Filtered DI Water (0.514 mg/L; 1.26% RSD)  
 Storm Run-Off (1.66 mg/L; 0.62% RSD)

## Optional Accessories

The 1080 TOC can be equipped with a number of instrument options and automation accessories to improve sample throughput and productivity.

### 88-position Rotary Autosampler

Model 1088 Rotary Autosampler is positioned below the TOC analyzer for convenient installation.

- Automated Dilution
- In-Situ Stirring
- 88 (40 mL) sample vials

### Total Bound Nitrogen (TN<sub>b</sub>)

The optional TN<sub>b</sub> Nitrogen detector allows measurement of total bound (inorganic and organic) nitrogen (excluding N<sub>2</sub>) in aqueous samples in tandem with TOC analysis.

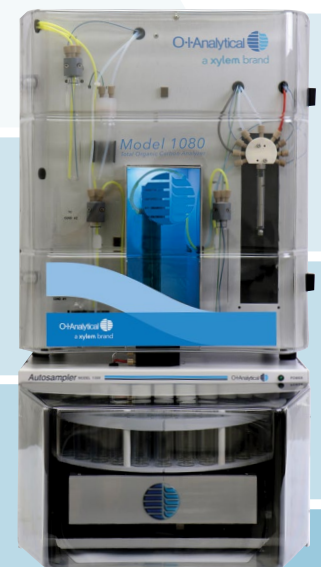



## 1080 Total Organic Carbon Analyzer Specifications

Method compliance	USEPA, CEN, USP, EUP, ASTM, ISO, DIN, STD methods
Measurement range (ppm)	50 ppb C - 2,000 ppm C
Method TC	680 °C with platinum catalyst
Method TIC	Acidification and sparging
Method TOC	NPOC, combustion of TIC-free sample, TOC by subtraction (TC-TIC)
Furnace temperature	Adjustable, 680 °C in 1°C increments; 720 °C for TNb
Measuring time	From three minutes
Oxidation technique	High temperature catalytic oxidation, liquid samples
Options available	TN <sub>b</sub>
Reproducibility	3.0%
Accuracy	±2% FS or 2% relative
Sample pathway	Color-coded Teflon® and PEEK® with automatic cleaning in all injection modes
Sample injection and sample handling	Injection: sipper, rotary autosampler Handling: automatic syringe with sliding TC furnace injector
Sample injection volume	50 µL - 2.0 mL in 10 µL increments
IC pretreatment	Available with autosampler
Certifications	CE; EMC: Directive 2014/30/EU; Safety: LVD 2014/35/EU; RoHS: Directive 2011/65/EU
Operation mode	Controlled via PC software (Windows 7, 8, 10 PRO)
Operating interface	Windows PC
Software (included)	Multi-instrument control via PC-based software; LIMS operation, data management, custom reports
Operating System	Windows® 7 (with Service Pack 1 or higher), Windows® 8, 8.1 & 10
Reagent purge	Yes
Reagents required	Hydrochloric acid, rinse water
Communications	USB-to-RS422 communications cable (5m length)
Input and output relays	Two user-programmable inputs, two user-programmable outputs
Ambient temperature range	10 °C - 37 °C
Operating humidity	<90% noncondensing
Power Requirements	115/230V AC, 50/60 Hz, 750VA max
Benchspace with autosampler	14" W x 19"D (35.6cm W x 48.3 cm D)
Gas type and grade	Oxygen or Air, 99.995% (carbon dioxide and hydrocarbon free), 50-60 psig
Dimensions	29" H x 14" W x 19" D (74 cm H x 36 cm W x 48 cm D)
Weight	17.5 kg (38.5 lbs), 37.5 kg (82.5 lbs) with autosampler option
Warranty	12 months on parts and labor

BROCHURE 4432-01



OI Analytical, a Xylem brand  
1725 Brannun Lane  
Yellow Springs, OH 45387

+1.979.690.1711  
xylem-lab@xylem.com  
oico.com

Microsoft® and Windows are registered trademarks of Microsoft Corporation.  
Teflon® is a registered trademark of E.I. DuPont de Nemours, Inc.  
OI Analytical® is a registered trademark of Xylem, Inc.  
\*U.S. & World Patents Pending

© 2021 Xylem, Inc. 4432-01 0721



[oico.com/1080TOC](http://oico.com/1080TOC)